

AURORA QUIK-LOK[®] SHELVING



More value, options, and quality

AURORA[®]
AURORA STORAGE PRODUCTS, INC.

AURORA QUIK-LOK SHELVING

More of Everything!



Quik-Lok Shelving

Make no mistake, Aurora Shelving is the original standard by which others are measured. Why settle for anything else?

Open or closed back, single or double entry, letter or legal, Aurora Shelving has the size, style, and accessories for storing everything.

Mobile Ready Shelving

Aurora Quik-Lok Shelving can be ordered "mobile ready" to install on Aurora Mobile system carriages.



Aurora Library Shelving™

Look in universities, schools, law offices, and libraries nationwide, and you'll find Aurora Library Shelving. The unique inner wall construction of Aurora Library Shelving allows easy access to even tightly packed books at the end of a row. Aurora also offers library carts.



Wood-Tek™

What do you get when you blend the strength of Aurora Shelving with the beauty of real wood? Wood-Tek, of course. Elegant shelving, cabinets, conference tables, or custom pieces can be ordered in two species of wood and four beautiful stains. Optional custom stains are available. Choose from traditional to contemporary styles.



MORE STORAGE, MORE SPACE.

For over 50 years Aurora has been offering the highest quality versatile shelving that assembles in a snap, no hardware required. If you want more value, options, and quality, turn to Aurora.

Imagine cutting your storage by 50% or more with Aurora Shelving.

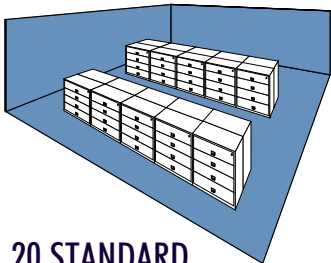

**20 STANDARD
LATERAL CABINETS**

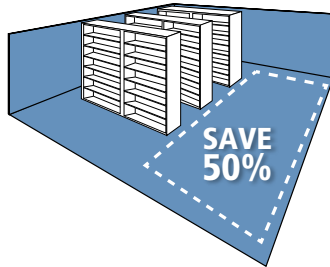

MORE WORK AREA

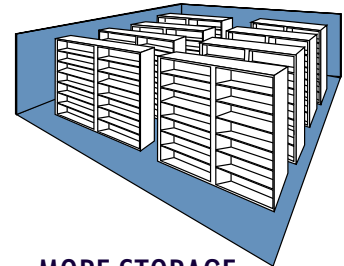

MORE STORAGE

Why Waste Space?

In the same room, 20 four-drawer lateral cabinets give you 3,200 filing inches. With Aurora, six 7-tier sections of double entry shelving give you 3,360 filing inches. You gain more storage and use only 50% of your space!

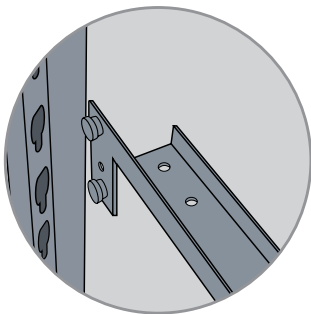

Quik-Lok®

No nuts, bolts, or screws required.

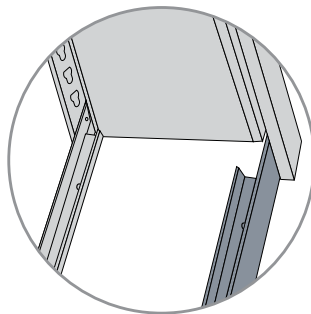

Quik-Base™

Quik-Base acts as shelf support, front base, and floor anchor all in one.

Easy Assembly

Quik-Lok Assembles in a Snap!

The key to easy assembly starts with our unique keyhole and rivet system. No nuts, bolts, sway braces, or hardware required.

Patented Quik-Base provides a sturdy foundation combining shelf support, front base, and floor anchor.

More Styles for Many Applications

Aurora Shelving comes in many styles for general storage, filing, wide-span, and library applications and also has flat files for archival and museum applications. Choose from a variety of accessory items such as doors, drawers, reference shelves and more to customize Aurora Shelving. Most types are also available as mobile ready for installation on Aurora Mobile Carriages to make a very space efficient high density storage system, saving as much as 50% of floor space or storing 100% more.



Quik-Lok Shelving



Standard Shelf Filing



Wide-Lok Wide Span



Library Shelving



Mobile Ready Shelving

Wide-Lok Wide Span Shelving

Our Wide-Lok Shelving assembles with minimal tools and has Special Beam and Stabilizers that allow for a wider span for weight loads from 1100-1800 lbs. for 1800 Series and 510-1100 lbs. for 1100 Series.



Aurora Wide-Lok™ Wide Span Shelving provides a strong, durable storage solution for larger and heavier objects such as:

- Bankers Boxes
- Military Ready Bags
- Museum Artifacts & Sculptures
- Bulk Storage
- Large Police Evidence
- Retail Goods

Flat Files

Aurora's heavy-duty welded flat files feature ball bearing slides and smooth drawer interiors with no catch points to harm material being stored. They are used for all sorts of storage including:

- Archives
- Maps
- Prints, Drawings
- Textiles
- Photos
- Posters
- Manuscripts
- Historic Material

Features

- 2" Drawers with 100 lbs. Capacity
- 5 Drawers per Unit
- Easy Glide Drawers with Dual Chrome Pulls
- Standard Label Holders
- Optional Floor Bases, 4" or 20" High
- Stack 3-High or Mount to Mobile Carriages

SHELVING SIZES

Heights*	Widths*	Depths
40 ¹ / ₄ ", 64 ¹ / ₄ ", 76 ¹ / ₄ ", 85 ¹ / ₄ ", 88 ¹ / ₄ ", 97 ¹ / ₄ ", 100 ¹ / ₄ ", 121 ¹ / ₄ "	24", 30", 36", 42", 48"	9", 10", 12", 13", 15", 16", 18", 20", 24", 26", 30", 32", 36"

*Custom heights in 1/2" increments or custom widths in 1/2" increments.

WIDE-LOK SIZES

Heights	Decking Widths	Decking Depths
40 ¹ / ₄ ", 64 ¹ / ₄ ", 76 ¹ / ₄ ", 85 ¹ / ₄ ", 88 ¹ / ₄ ", 97 ¹ / ₄ ", 100 ¹ / ₄ ", 121 ¹ / ₄ "	54", 60", 66", 72", 78", 84", 90", 96"	15", 18", 24", 26", 30", 32", 36"



FILE SIZES

Height	Widths	Depths
15 ¹ / ₂ "	40 ¹ / ₂ "	28 ¹ / ₂ "
15 ¹ / ₂ "	46 ¹ / ₂ "	35 ¹ / ₂ "
15 ¹ / ₂ "	53 ¹ / ₂ "	41 ¹ / ₂ "

AURORA QUIK-LOK SHELVING

More Colors and Designs

Aurora Quik-Lok Shelving is available in 31 elegant colors and unlimited custom colors to create the look you want, or to blend with the space you already have. Eight beautiful colors are offered for quick ship on the XPRESS program.

Where Design Meets Science

A special Gloss-Tek™ finish incorporates antimicrobial properties for a healthier environment.

End Panel Design Options

End Panel options include steel, laminate, and Wood-Tek™.

Wood-Tek End Panels are available in cherry or maple in four beautiful stains or in custom stains and woods.

Order End Panels in standard laminates or slat wall for display purposes.



Gloss-Tek Colors



Slat Wall



Laminates

Laminates

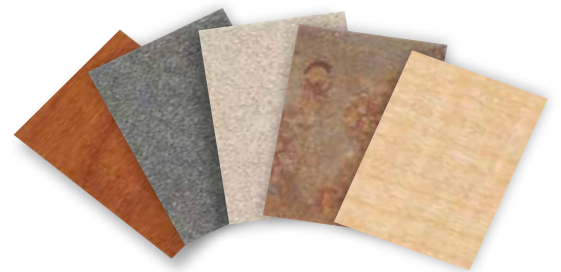

Wood-Tek



Our Environmental Pledge

We use environmentally friendly Gloss-Tek™ powder coat finish on our Aurora Quik-Lok Shelving. This finish is 100 percent non-emissive; free of formaldehyde, methanol, and other solvents; and completely friendly to artifacts, specimens, and documents.

No wonder we say that with Aurora, any color you choose is "green."

AURORA QUIK-LOK SHELVING

Accessories



Gun Racks



Bin Dividers



Retractable Doors

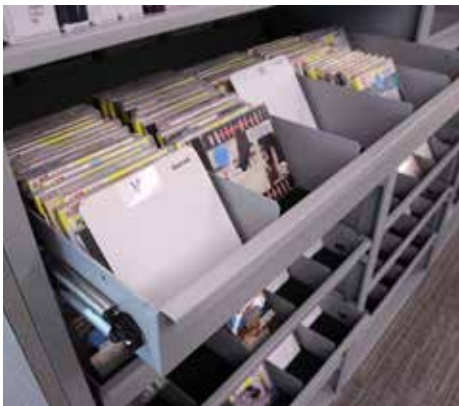

Browser Boxes



Library Display Shelving



Extended Height Adjustable Dividers



Sliding Doors



Single or Double Quik-Doors™



Quik-Roll™ Doors

AURORA QUIK-LOK SHELVING

Accessories



Magazine Doors



Special Brackets
for Hanging Media



Bookcases



Workstation Units



Reference Shelves



Wall Mounted Units



File Dividers



Library Carts



Filing and Divided Drawers
*(shown with optional
Electronic Keypad Lock)*



End-Stor™



Combination Units

AURORA QUIK-LOK SHELVING

Applications

Government, Military, and Law Enforcement

- Weapons Storage
- Parking Tickets
- Fingerprint Cards
- Evidence Storage
- Ready Bags
- Uniforms



General and Light Industrial

- Stock, Small Parts
- Warehousing
- Distribution Centers





Hospitals, Clinics, Pharmacies, and Veterinary Centers

- Medical Records
- Pharmaceuticals
- Samples
- Bulk Storage
- Uniform Storage
- Waiting Rooms



Libraries

- Reference Material
- Book Display
- Periodical Display
- Browser Boxes
- Collections

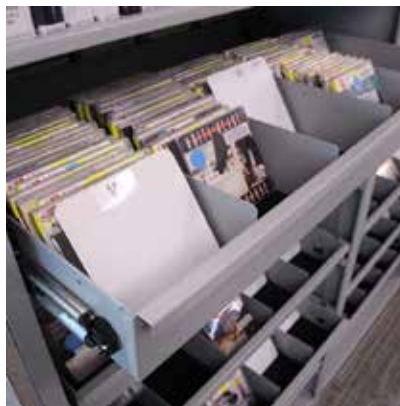

AURORA QUIK-LOK SHELVING

Applications

Education

- K-8, High Schools, Universities
- Libraries
- Athletic Departments
- Bookstores
- Janitor Closets
- Personal Storage for Teachers
- Administrative Offices
- Lunchroom Storage



Retail and Food Service

- Merchandise Storage
- Retail Display
- Stockroom Storage
- Utensil and Food Storage

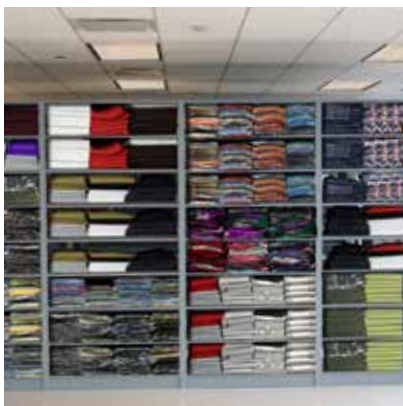

Banks, Credit Unions, and Insurance Companies



- Client Files
- Auto Loan Files
- Mortgage Files
- Home Equity Files
- Vaults



Law Firms

- Client Files
- War Rooms
- Binder Storage
- Exhibit Storage
- Reference Libraries
- Artwork/Frames





**When you want top shelf, only Aurora will do.
More Value, Options, and Quality**



Aurora Storage Products, Inc.
600 South Lake Street • Aurora, IL 60506
Ph: 630-897-6951 • Fax: 630-897-6994
Toll Free: 800-277-1699

www.aurorastorage.com

All Rights Reserved Copyright © 2018
AQLB03-18 3M



For more information go to:
<http://www.aurorastorage.com/>

For design assistance:
designsupport@aurorastorage.com

GSA Contract Holder
Contract GS-25F-0084M
U.S. Small Business Enterprise